



## Constant Current 15 Watt LED Driver

GRE Alpha's ELC 15 is a 15W Constant Current LED Driver. This compact and efficient LED Driver features dip-switch selectable output currents making it the most versatile and flexible LED driver suitable for a wide variety applications, whilst ensuring, consistent, high quality performance of your luminaire at all times.

### ELC 15

#### Constant Current 15 Watt LED Driver



#### Model Selection Key

#### ELC 15-BCV-D

SWC: Euro & Asia market

B:1 channel output;  
C:Max Vout; V:Voltage

Max Output Power

Series Name

#### Features

- 220 ~ 240Vac input
- Up to 88% Efficiency
- Selectable current output
- PF>0.9 at full load
- Built-in protection: SCP,OVP,OCP
- CB, CE, SAA
- For luminaires of protection Class II and Class III
- 3 years Warranty

| Model Number   | Input Voltage Range (V <sub>AC</sub> ) | Channel(s) Output | CC Output                                      |                              |                                       |     | Max. Output Power (W) | Rated Output Power(W) |
|----------------|--|-------------------|--|------------------------------|---------------------------------------|-----|-----------------------|-----------------------|
|                |  |                   | Preset Max. I <sub>out</sub> (Per Channel) (A) | Current selectable values(A) | Compliance Voltage (V <sub>DC</sub> ) |     |                       |                       |
|                |  |                   |  |                              | min                                   | max |                       |                       |
| ELC15-115V-SWC | 220-240                                | 1                 | 1.05   | 1.05/0.7/0.5/0.35            | 7.5                                   | 15  | 16                    | 16                    |
| ELC15-124V-SWC | 220-240                                | 1                 | 0.7  | 0.7/0.5/0.4/0.35             | 12                                    | 24  | 17                    | 17                    |
| ELC15-136V-SWC | 220-240                                | 1                 | 0.4  | 0.4/0.35/0.3/0.2             | 18                                    | 36  | 14                    | 14                    |

## Input Specification

|                 |                      |   |                                |
|-----------------|----------------------|---|--------------------------------|
| Voltage Range   | 220 ~240VAC          | Vmax Inrush Current                             | Cold start-up:<20Amp peak@25°C |
| Frequency Range | 47-63 Hz             | Max. No. of Units on circuit breaker 10A Type B | 30                             |
| Power Factor    | 0.9 min at Full load | Max. No. of Units on circuit breaker 16A Type B | 40                             |
| THD             | <20% @Full load      |   |                                |

## Output Specification

|                           |                    |                               |  |
|---------------------------|--------------------|-------------------------------|--|
| Max Power                 | 15 W               | Noise/Ripple                  | 7% of Rated Output Volts ; +/- 30% of Output Current (Note: All noise measurements made at the output terminals, connected to a 20Mhz low pass filter) |
| Efficiency                | 88%*               | Short Circuit Protection      | Hiccup-Mode, Auto-Recovery upon removal of short circuit condition   |
| Output Current Regulation | +/- 5% Max         | Over Voltage Protection       | CV Condition   |
| Start-up Time             | 1 sec. Typical     | Over-current Protection (OCP) | CC Condition   |
| Hold-up Time              | 0.5mS @ full load, |                               |  |

\* : at 230V Vac input, full load

## Environmental Specifications

| MTBF  | Cooling    | Operating Temp            | Storage Temp | Relative Humidity |
|---|------------|---------------------------|--------------|-------------------|
| 50,000 hours<br>(Full Load @ 25C ambient,<br>Based on MIL-217F) | Convection | -25°C-50°C<br>(Full load) | -40°C- 85°C  | 5% - 95 %         |

## Compliance / Safety







|                 |  |
|-----------------|--|
| EMI/RFI         | ISPR-22 Class B, IEC61547, IEC61000-3-2, IEC 61000-3-3, EN55015, EN61000-3-2, EN 61000-3-3, EN 61547 |
| Safety Agencies | CB, CE (IEC61347-1, IEC61347-2-13)   |
| Weatherability  | IP20   |

## Expected Life-time\*

|           |         |         |
|-----------|---------|---------|
| Ta        | 40°C    | 50°C    |
| Tc        | 65°C    | 75°C    |
| Life-time | 50,000h | 30,000h |

\*: @ Full load, based on a failure rate of < 10%

## Pin Assignment

|                |   |   |   |   |                |
|----------------|---|---|---|---|----------------|
| Setting        |  |  |  |  | ELC15-115V-SWC |
| Output Current | 1050 mA   | 700 mA  | 500 mA  | 350 mA  |                |
| Setting        |  |  |  |  | ELC15-124V-SWC |
| Output Current | 700 mA  | 500 mA  | 400 mA  | 350 mA  |                |
| Setting        |  |  |  |  | ELC15-136V-SWC |
| Output Current | 400 mA  | 350 mA  | 300 mA  | 200 mA  |                |

## Connectors

|           |                       |
|-----------|-----------------------|
| AC Input  | Neutral (N), Live (L) |
| DC Output | V+, V-                |

## Mechanical

|                             |                                 |
|-----------------------------|---------------------------------|
| Case Design                 | Materials / Polycarbonate white |
| Maximum torque (fixing)     | 0.4Nm/M2                        |
| Terminal block screw torque | 0.3Nm/M2.6                      |

# Performance Curves

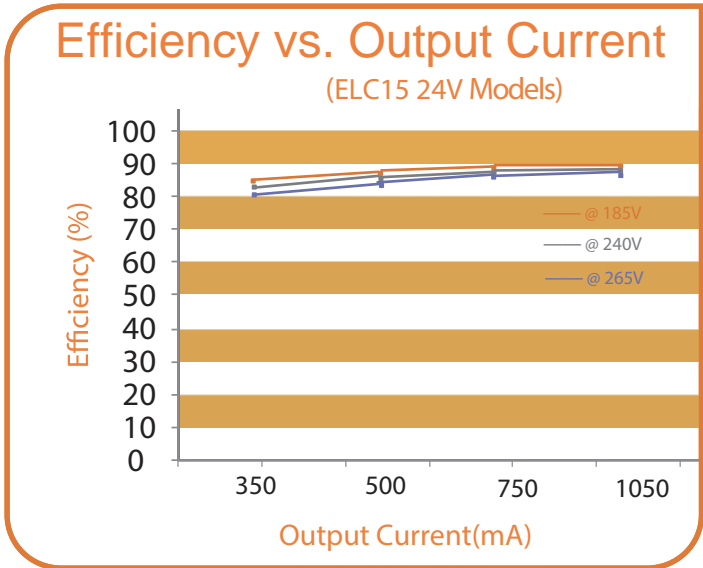
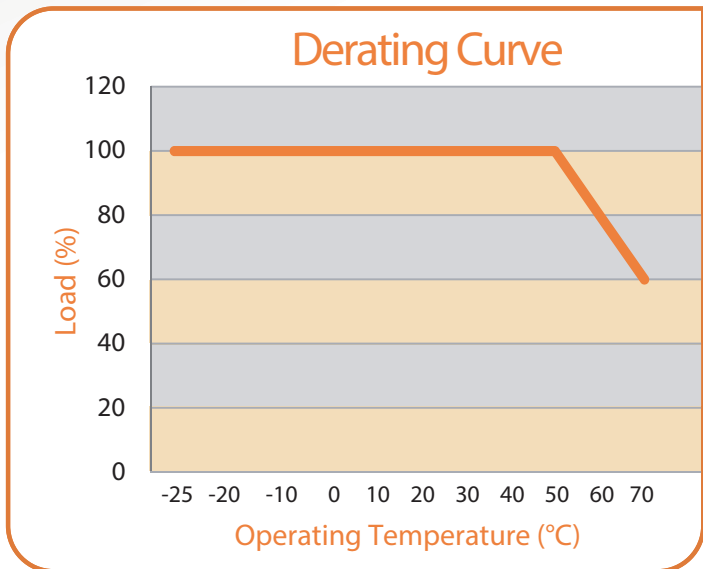
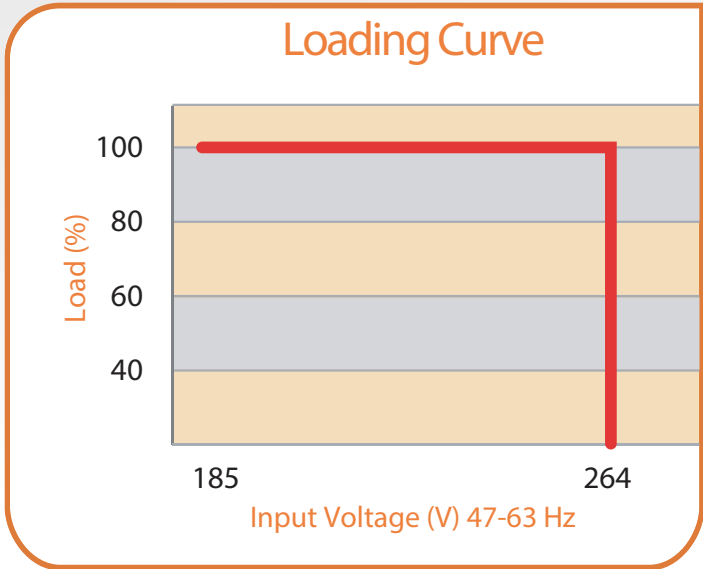
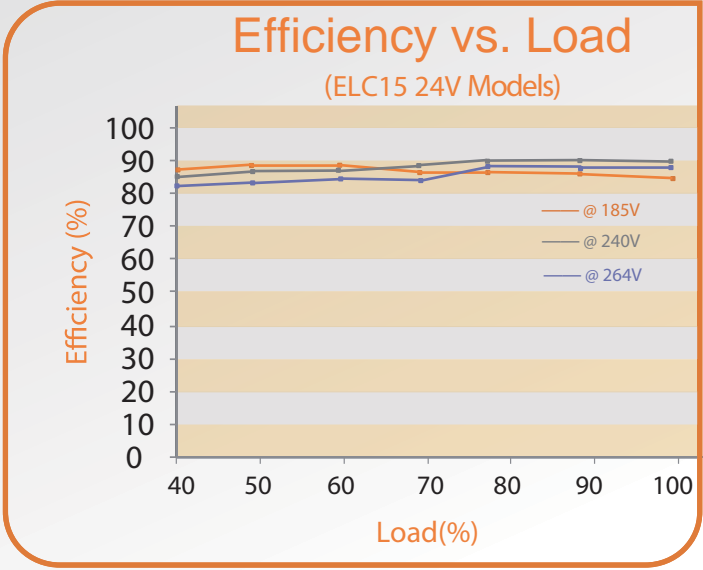
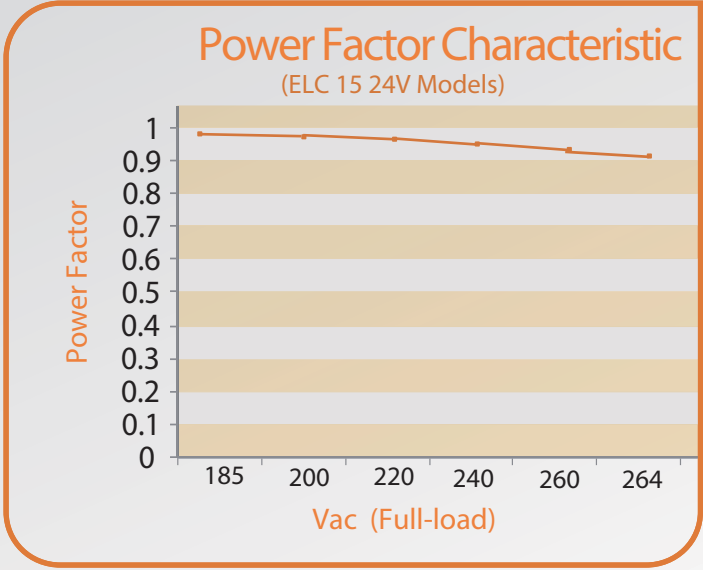

## Mechanical Diagrams

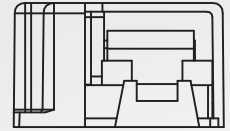
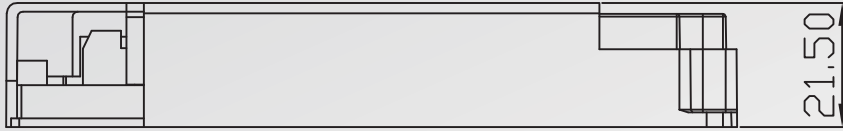

Packing Information  
 Weight: 0.085 kg/pcs, 10.0 kg/carton 100 pcs/carton;  
 L480xW275xH183 (mm)

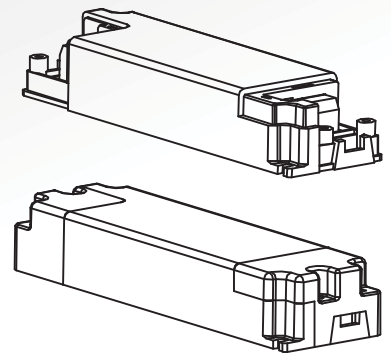
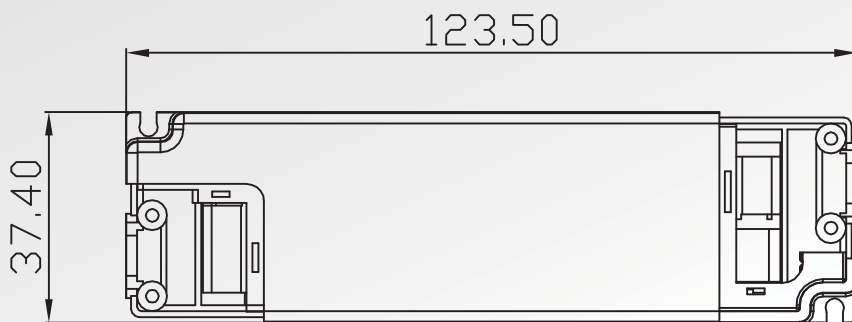

## Wiring Diagram



## Wiring Instructions

- 1) Installation of the ELC series power unit requires the proper wiring connection of both the AC terminal block to the AC facility power, and the DC terminal block to the LED lighting system. (Note: All electrical wiring should comply with local and national electrical codes. Installation should be performed by qualified electrical service personnel.)
- 2) To access both the AC and DC terminal blocks, remove the side covers by removing the 2 screws on each side using a Philips screwdriver.
- 3) Connect the AC source wires to the ELC power unit's AC input terminal blocks using a slot type screwdriver. Refer to the rating label affixed on the ELC power unit for AC wire connection. The "L" terminal block from the ELC unit should connect to the incoming AC Line wire. The "N" terminal block from the ELC unit should connect to the incoming AC Neutral wire.
- 4) Connect the ELC unit DC output to the LED lighting system by connecting the LED lighting system input wires to the ELC unit's DC output V+ and V- terminal blocks using a slot type screwdriver. Refer to the rating label affixed on the ELC power unit for DC wire connection. The V- terminal block from the ELC unit should connect to the lighting system's DC negative input, '-'. The V+ terminal block from the ELC unit should connect to the lighting system's DC positive input, '+'.  
5) Once all wiring is completed, turn on the AC supply to check for proper LED lighting system operation. Once proper operation is confirmed, turn off the AC supply and then re-install the side covers of the ELC power unit, using the 4 screws and Philips screwdriver.

Information furnished is believed to be accurate and reliable. However, GRE Alpha assumes no responsibility for the consequences of use of such information nor for any infringement of patents or other rights of third parties which may result from its use. No license is granted by implication or otherwise under any patent or patent rights of GRE Alpha. Specifications mentioned in this publication are subject to change without notice. This publication supersedes and replaces all information previously supplied.

The GRE Alpha logo is a registered trademark of GRE Alpha Electronics Ltd.  
All other names are the property of their respective owners