



Constant Current 25 Watt LED Driver

GRE Alpha's ELC 25 is a 25W Constant Current LED Driver. This compact and efficient LED Driver features dip-switch selectable output currents making it the most versatile and flexible LED driver suitable for a wide variety applications, whilst ensuring, consistent, high quality performance of your luminaire at all times.

ELC 25

Constant Current 25 Watt LED Driver



Model Selection Key

ELC 25-BCV-D

SWC: Euro & Asia market

B:1 channel output;
C:Max Vout; V:Voltage

Max Output Power

Series Name

Features

- 220 ~ 240Vac input
- Up to 88% Efficiency
- Selectable current output
- PF>0.9 at full load
- Built-in protection: SCP,OVP,OCP
- CB, CE, SAA
- For luminaires of protection Class II and Class III
- 3 years Warranty

Model Number	Input Voltage Range (V _{AC})	Channel(s) Output	CC Output				Max. Output Power (W)	Rated Output Power(W)
			Preset Max. I _{out} (Per Channel) (A)	Current selectable values(A)	Compliance Voltage (V _{DC})			
					min	max		
ELC25-125V-SWC	220-240	1	1.05	1.05/0.7/0.5/0.35	12.5	25	26	26
ELC25-136V-SWC	220-240	1	0.7	0.7/0.5/0.4/0.35	18	36	25	25

Input Specification

Voltage Range	220 ~240VAC	Vmax Inrush Current	Cold start-up:<20Amp peak@25°C
Frequency Range	47-63 Hz	Max. No. of Units on circuit breaker 10A Type B	20
Power Factor	0.9 min at Full load	Max. No. of Units on circuit breaker 16A Type B	30
THD	<20% @Full load		

Output Specification

Max Power	25 W	Noise/Ripple	7% of Rated Output Volts ; +/- 30% of Output Current (Note: All noise measurements made at the output terminals, connected to a 20Mhz low pass filter)
Efficiency	88%*	Short Circuit Protection	Hiccup-Mode, Auto-Recovery upon removal of short circuit condition
Output Current Regulation	+/- 5% Max	Over Voltage Protection	CV Condition
Start-up Time	1 sec. Typical	Over-current Protection (OCP)	CC Condition
Hold-up Time	0.5mS @ full load,		

* : at 230V Vac input, full load

Environmental Specifications

MTBF	Cooling	Operating Temp	Storage Temp	Relative Humidity
50,000 hours (Full Load @ 25C ambient, Based on MIL-217F)	Convection	-25°C-50°C (Full load)	-40°C- 85°C	5% - 95 %

Compliance / Safety

EMI/RFI	ISPR-22 Class B, IEC61547, IEC61000-3-2, IEC 61000-3-3, EN55015, EN61000-3-2, EN 61000-3-3, EN 61547
Safety Agencies	CB, CE (IEC61347-1, IEC61347-2-13)
Weatherability	IP20

Expected Life-time*

Ta	40°C	50°C
Tc	65°C	85°C
Life-time	50,000h	30,000h

*: @ Full load, based on a failure rate of < 10%









Connectors

AC Input	Neutral (N), Live (L)
DC Output	V+, V-

Mechanical

Case Design	Materials / Polycarbonate white
Maximum torque (fixing)	0.4Nm/M2
Terminal block screw torque	0.3Nm/M2.6

Pin Assignment

Setting					
Output Current	1050 mA	700 mA	500 mA	350 mA	ELC25-125V-SWC
Setting					
Output Current	700 mA	500 mA	400 mA	350 mA	ELC25-136V-SWC

Performance Curves

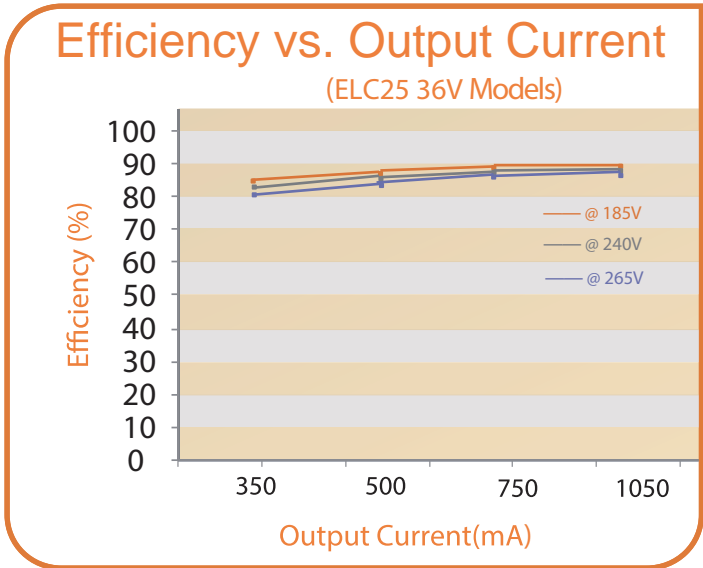
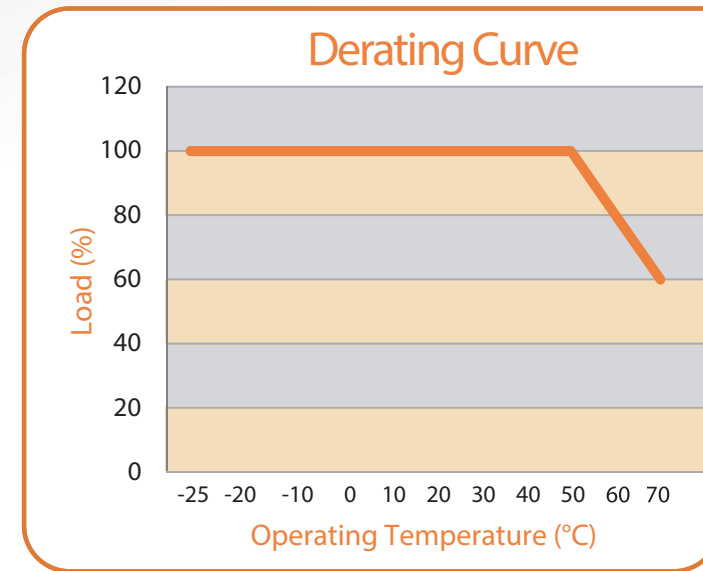
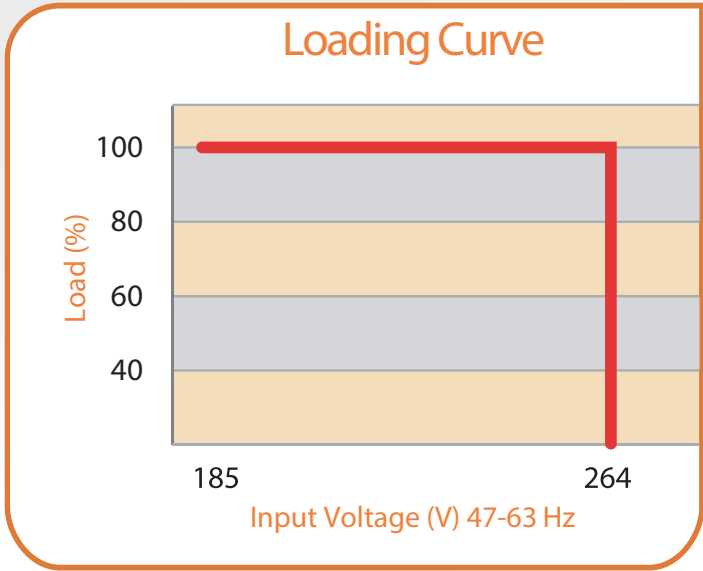
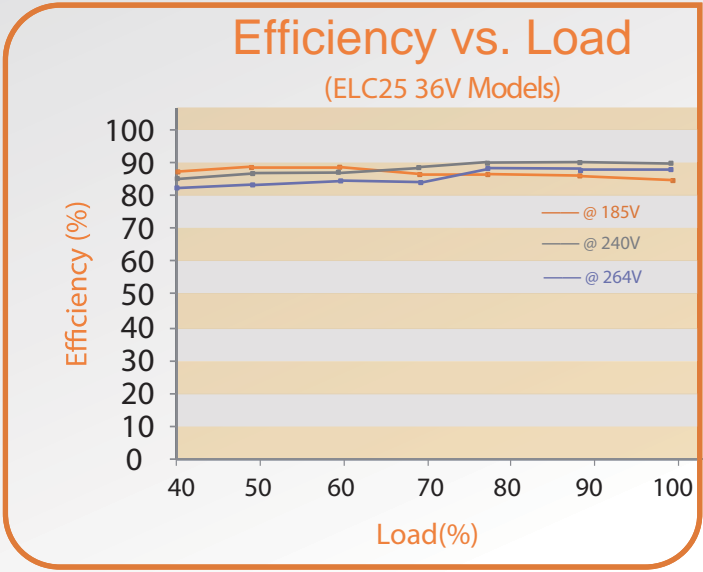
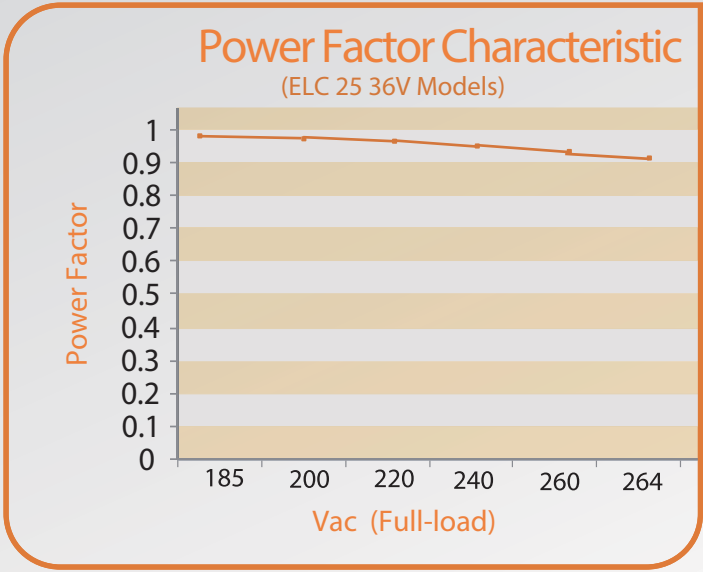

Mechanical Diagrams

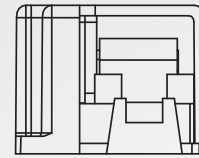
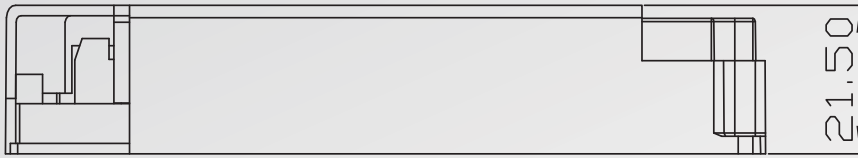

Packing Information
 Weight: 0.121 kg/pcs, 13.5 kg/carton 100 pcs/carton;
 L480xW317xH183 (mm)

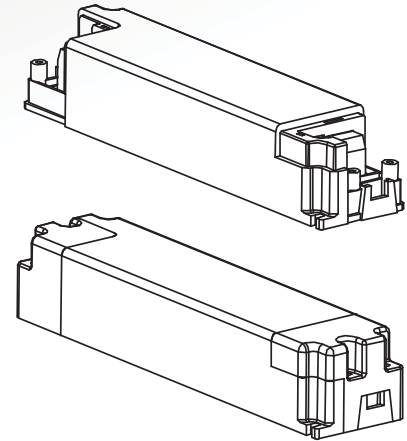
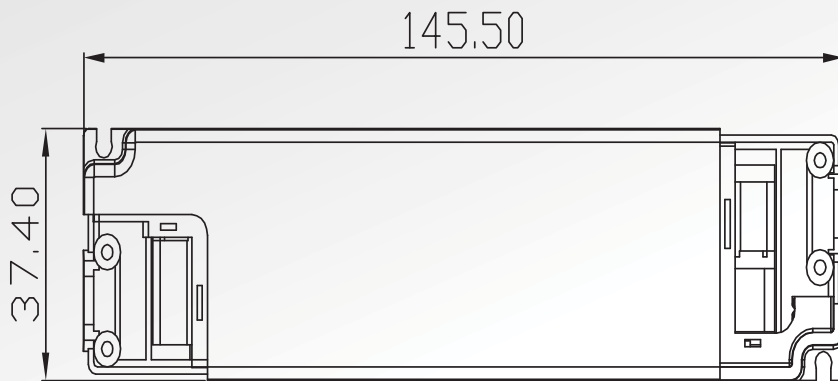

Wiring Diagram



Wiring Instructions

- 1) Installation of the ELC series power unit requires the proper wiring connection of both the AC terminal block to the AC facility power, and the DC terminal block to the LED lighting system. (Note: All electrical wiring should comply with local and national electrical codes. Installation should be performed by qualified electrical service personnel.)
- 2) To access both the AC and DC terminal blocks, remove the side covers by removing the 2 screws on each side using a Philips screwdriver.
- 3) Connect the AC source wires to the ELC power unit's AC input terminal blocks using a slot type screwdriver. Refer to the rating label affixed on the ELC power unit for AC wire connection. The "L" terminal block from the ELC unit should connect to the incoming AC Line wire. The "N" terminal block from the ELC unit should connect to the incoming AC Neutral wire.
- 4) Connect the ELC unit DC output to the LED lighting system by connecting the LED lighting system input wires to the ELC unit's DC output V+ and V- terminal blocks using a slot type screwdriver. Refer to the rating label affixed on the ELC power unit for DC wire connection. The V- terminal block from the ELC unit should connect to the lighting system's DC negative input, '-'. The V+ terminal block from the ELC unit should connect to the lighting system's DC positive input, '+'.
- 5) Once all wiring is completed, turn on the AC supply to check for proper LED lighting system operation. Once proper operation is confirmed, turn off the AC supply and then re-install the side covers of the ELC power unit, using the 4 screws and Philips screwdriver.

Information furnished is believed to be accurate and reliable. However, GRE Alpha assumes no responsibility for the consequences of use of such information nor for any infringement of patents or other rights of third parties which may result from its use. No license is granted by implication or otherwise under any patent or patent rights of GRE Alpha. Specifications mentioned in this publication are subject to change without notice. This publication supersedes and replaces all information previously supplied.

The GRE Alpha logo is a registered trademark of GRE Alpha Electronics Ltd.
All other names are the property of their respective owners